

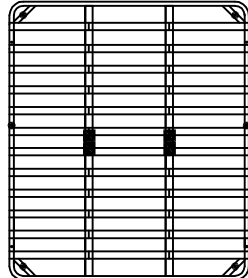
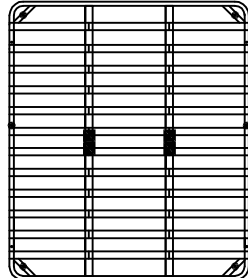

安装示意图/Assembly Instruction

产品名称 Model NO.	TBC086	排骨架规格 Ranked bed slat specifications
产品规格 Specification	1500*2000	(1500*2000)
组合尺寸 Combined size	2190*1550*1060mm	

配件表/Accessories list

编号 NO.	名称 Name	图示 Icon	数量 QTY	编号 NO.	名称 Name	规格 Specification	数量 QTY	材质 Material
A	说明书 (含安装图) Mounting Instruction (with drawing)		1	①	床头 The head of a bed	1550*180*1060	1	实木+夹板+海绵+科技布+公仔棉 Solid wood + plywood + sponge + technical cloth + doll cotton
B	M8*20斜边十字螺栓 M8*20 bevel cross bolt		44	②	床侧 Side of the bed	1985*35*140	2	实木+夹板+海绵+科技布 Solid wood + plywood + sponge + technical cloth
C	M8垫片 M8 pad		40	③	床尾 The end of the bed	1520*35*140	1	实木+夹板+海绵+科技布 Solid wood + plywood + sponge + technical cloth
D	3号角码 corner bracket NO.3		4	<div style="display: flex; justify-content: space-around;"> <div style="text-align: center;"> <p>● 排骨架脚 Row frame foot</p>  </div> <div style="text-align: center;"> <p>■ T型排骨架脚 T-shaped row frame foot</p>  </div> </div>				
E	1号角码 corner bracket NO.1		4					
F	M5*30自攻螺丝 M5*30 self tapping screw		12					
G	沙发脚 Foot		4					
H	M8*45斜边十字螺栓 M8*45 bevel cross bolt		2					
I	8厘外六角螺母 M8 external hexagon nut		4					
J	T型排骨架中脚28.5cm高 T-shaped row frame middle foot 28.5cm		1					
K	排骨架边脚25cm高 Row frame edge 25cm		6					
L	30*145-160mm可调一字五金脚 30*145-160mm adjustable slotted hardware foot		1					
M	M8*45全牙螺杆 M8*45 full tooth screw		1					
N	灰色毛毡 Grey felt		2					
O	新5号角码 New 5 corner		2					
P	排骨架 Row skeleton		1					

制图 Draw 0 Page NO. 页码 (1-1)

安装工具 Tool 安装人数 Installer

充电式手电钻 或者 十字螺丝刀
Cordless hand drill
Phillips screwdriver

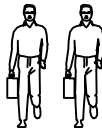
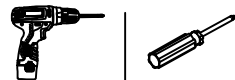

如何区分床的左右方向?
How to distinguish the left and right directions of the bed?

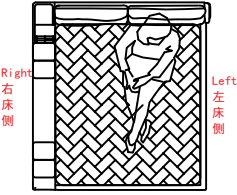

人躺在床上, 分左右方向
Lie on the bed, facing left and right
(图示仅供分辨方向用)

图1: 床脚安装示意图
Figure 1: installation diagram of bed foot



图2: 角码安装示意图
Figure 2: installation diagram of corner code



图3: 新5号角码安装示意图
Figure 3: installation diagram of new No. 5 corner code

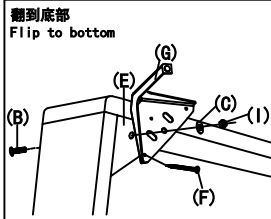

STEP 1:
床头、床边安装示意图
Installation diagram of bedside and bedside

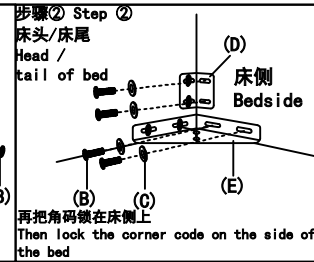
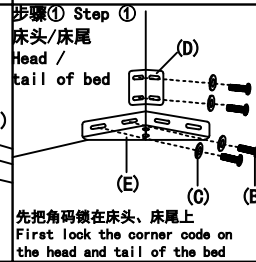
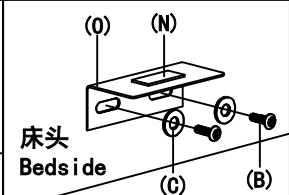
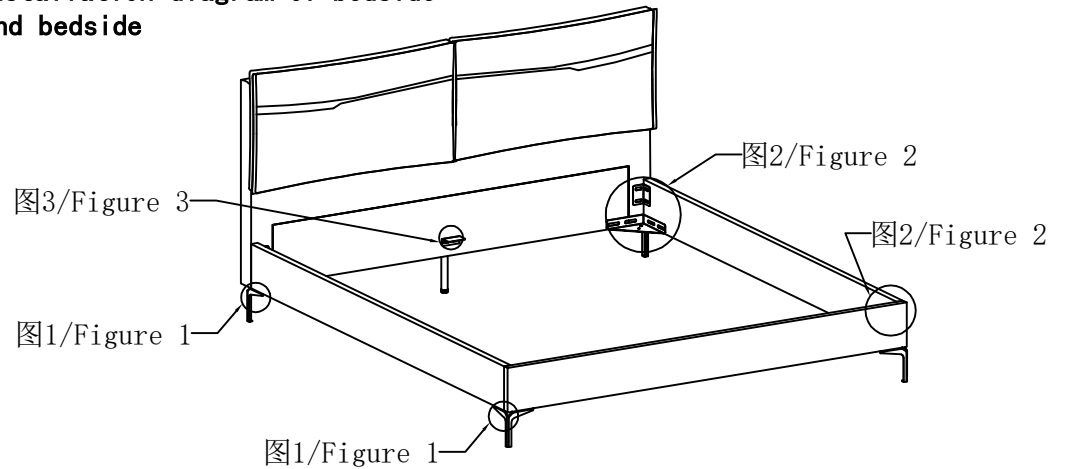

STEP 2:
排骨架安装示意图
Installation diagram of row frame

